

# Dichtungsprofil Nr. 125 (Schiebetüren)

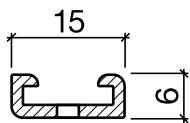

Nr. 125

## HEBGO-Halteprofil aus Aluminium

vorgelocht 2,9 mm, alle 150 mm

Lagerlänge 5250 mm (☼ = 20)

- 125.0** blank
- 125.1** farblos eloxiert
- 125.2** bronzefarbig eloxiert



Nr. 523

## HEBGO-Schleifdichtung, EPDM-Qualität

Lagerlänge 5250 mm

- 523.1** schwarz

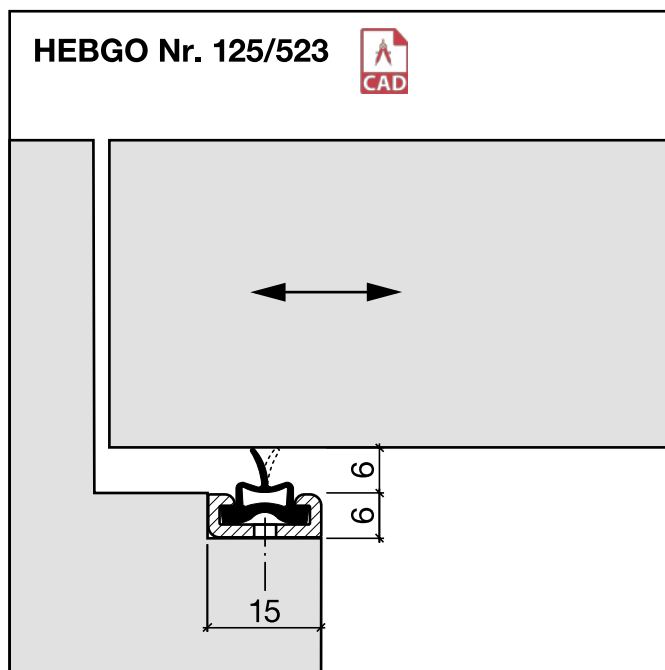

# Schwellenprofil Nr. 176 (Thermo-Schwelle, 2-teilig, steckbar)

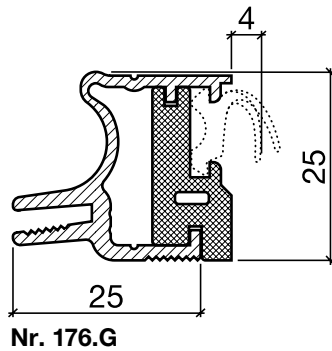
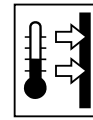

## HEBGO-Schwellenprofil aus Aluminium Grundprofil, mit Kunststoff-Isolator, grau

Lagerlänge 1100 mm

- 176.G0 blank
- 176.G1 farblos eloxiert
- 176.G2 bronzefarbig eloxiert

Lagerlänge 2500 mm

- 176.G01 blank
- 176.G11 farblos eloxiert
- 176.G21 bronzefarbig eloxiert

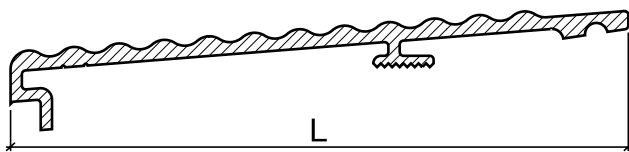

- Nr. 177.W L = 82 mm
- Nr. 179.W L = 106 mm

## HEBGO-Schwellenprofil aus Aluminium Steckprofil

Lagerlänge 5250 mm (☼ = 5)

- 177.W0 blank
- 177.W1 farblos eloxiert
- 177.W2 bronzefarbig eloxiert

- 179.W0 blank
- 179.W1 farblos eloxiert
- 179.W2 bronzefarbig eloxiert



Nr. 620

## HEBGO-Lippendichtung, TPE-Qualität

Rollen à 50 m

- 620.1 schwarz
- 620.2 braun

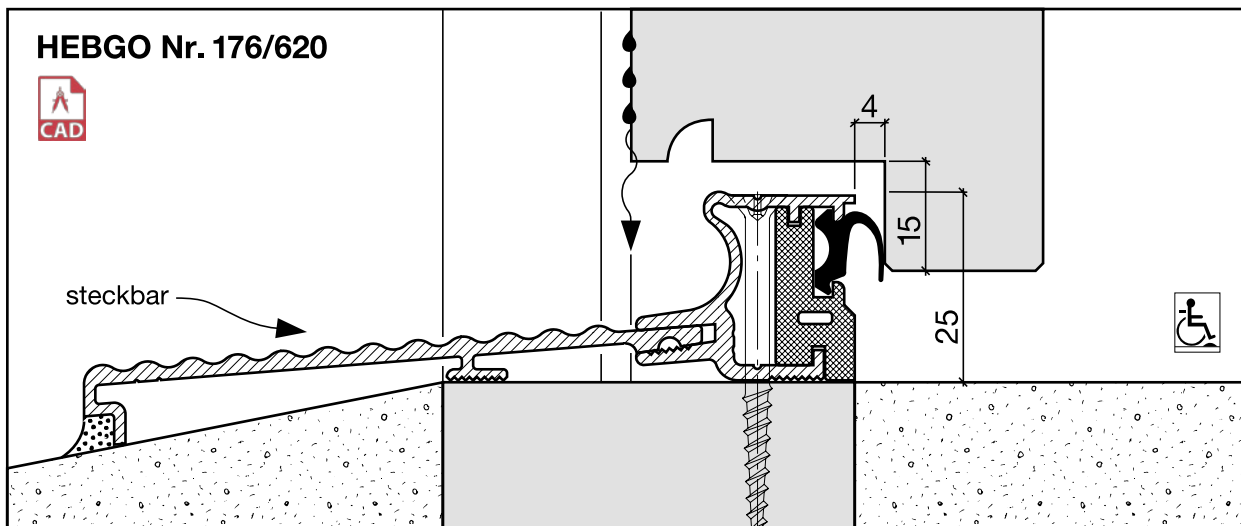

## Variante "Plus" (mit Schleifdichtung für extreme Schlagregensicherheit)

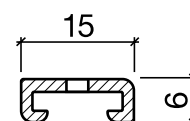
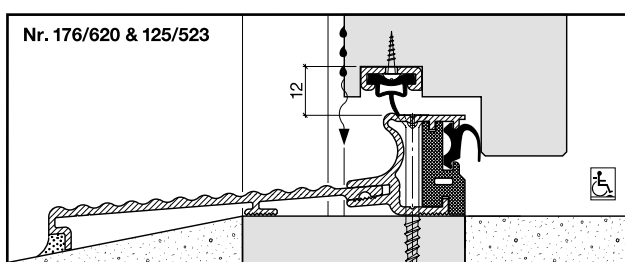

Nr. 125



Nr. 523

Profildetails siehe Seite B, 08

# Schwellenprofil Nr. 178

(Thermo-Schwelle, 2-teilig, steckbar)

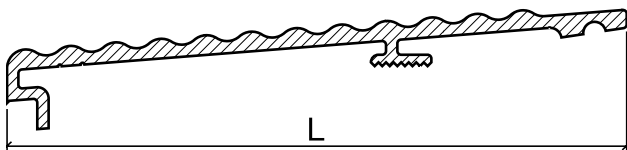
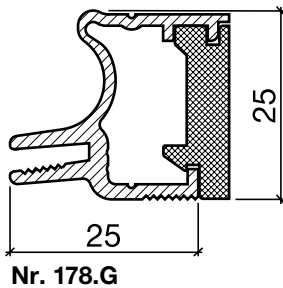
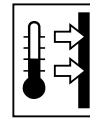

Nr. 177.W L = 82 mm  
 Nr. 179.W L = 106 mm



## HEBGO-Schwellenprofil aus Aluminium

Grundprofil, mit Kunststoff-Isolator, grau

Lagerlänge 1100 mm

- 178.G0 blank
- 178.G1 farblos eloxiert
- 178.G2 bronzefarbig eloxiert

Lagerlänge 2500 mm

- 178.G01 blank
- 178.G11 farblos eloxiert
- 178.G21 bronzefarbig eloxiert

## HEBGO-Schwellenprofil aus Aluminium

Steckprofil

Lagerlänge 5250 mm (☼ = 5)

- 177.W0 blank
- 177.W1 farblos eloxiert
- 177.W2 bronzefarbig eloxiert

- 179.W0 blank
- 179.W1 farblos eloxiert
- 179.W2 bronzefarbig eloxiert

## HEBGO-Kombidichtung, Silikon-Qualität

Rollen à 50 m

- |          |             |              |
|----------|-------------|--------------|
| 535.7038 | grau        | RAL-Nr. 7038 |
| 535.8003 | HEBGO-braun | RAL-Nr. 8003 |
| 535.8019 | graubraun   | RAL-Nr. 8019 |
| 535.9010 | weiss       | RAL-Nr. 9010 |
| 535.9011 | schwarz     | RAL-Nr. 9011 |

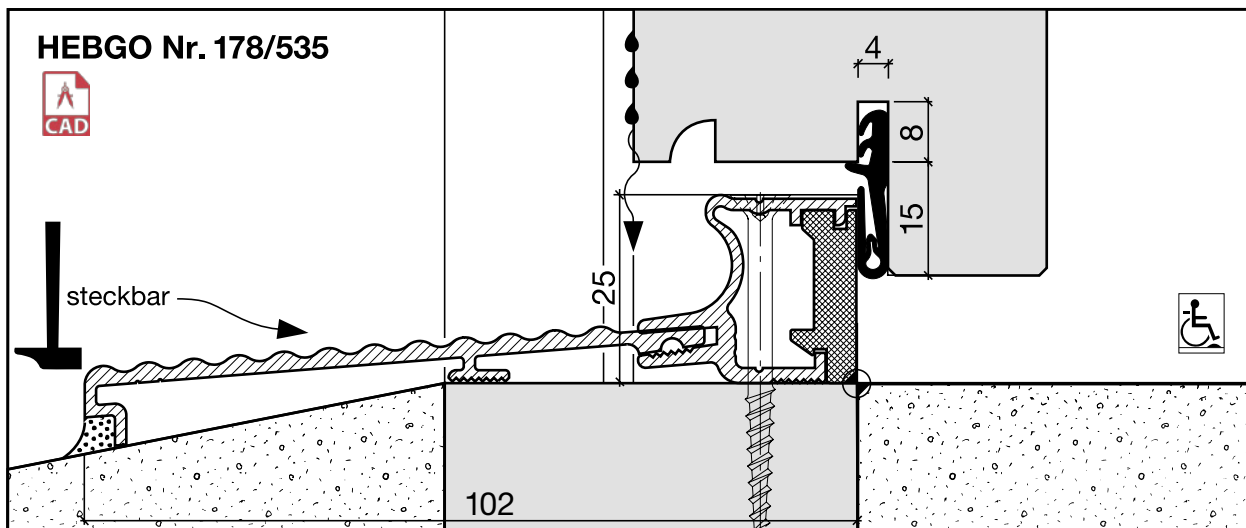

### Variante "Plus" (mit Schleifdichtung für extreme Schlagregensicherheit)

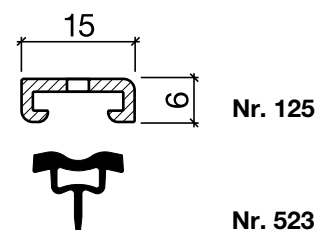
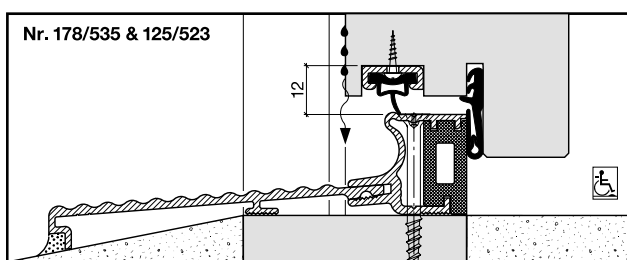

Profildetails siehe Seite B. 08