

Dichtungsprofil Nr. 125 (Türen)

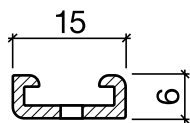

Nr. 125

HEBGO-Halteprofil aus Aluminium

vorgelocht 2,9 mm, alle 150 mm

Lagerlänge 5250 mm (☼ = 20)

- 125.0** blank
- 125.1** farblos eloxiert
- 125.2** bronzefarbig eloxiert



Nr. 520

HEBGO-Hohlkammerdichtung, TPE-Qualität

Rollen à 50 m

- 520.1** schwarz



Nr. 620

HEBGO-Lippendichtung, TPE-Qualität

Rollen à 50 m

- 620.1** schwarz
- 620.2** braun EPDM

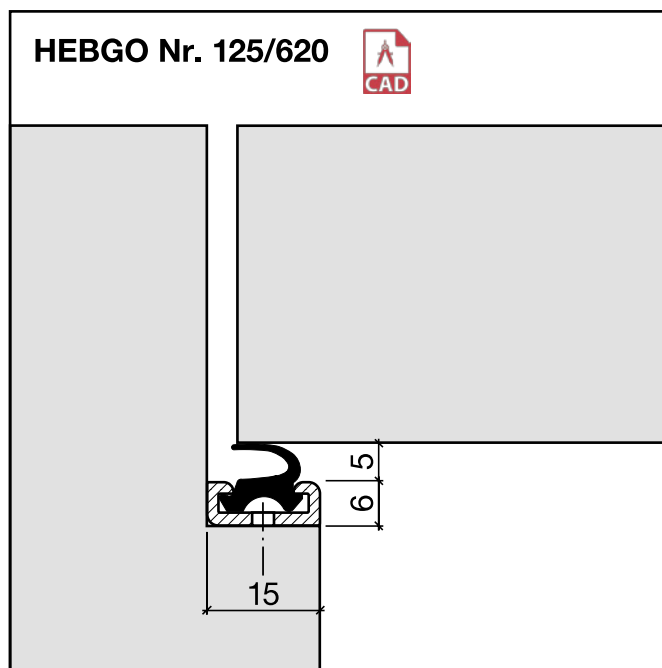
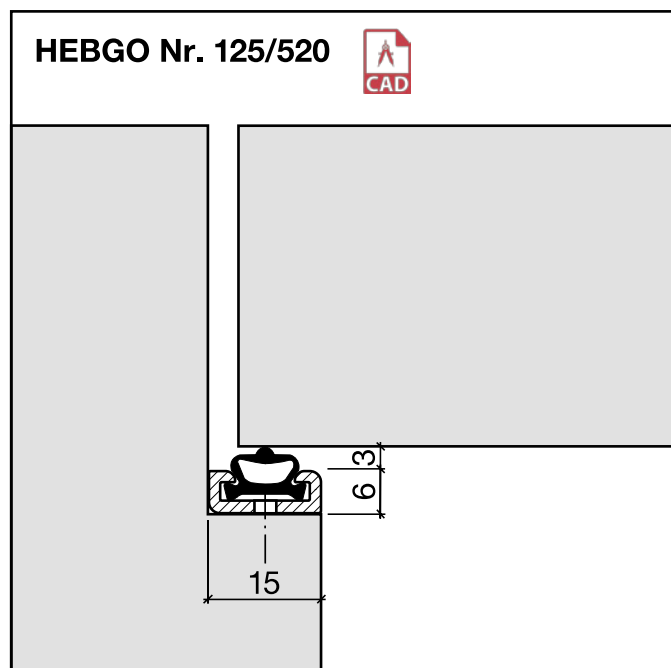

Schwellenprofil Nr. 176
(Thermo-Schwelle, 2-teilig, steckbar)

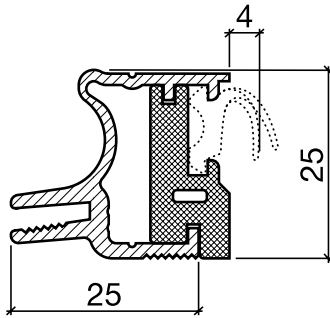
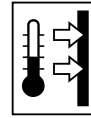

Nr. 176.G

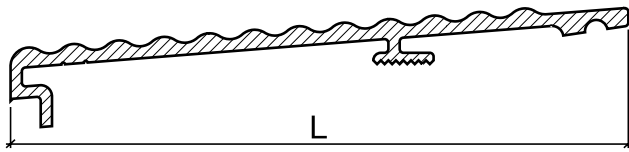

Nr. 177.W L = 82 mm
Nr. 179.W L = 106 mm



Nr. 620

HEBGO-Schwellenprofil aus Aluminium
Grundprofil, mit Kunststoff-Isolator, grau

Lagerlänge 1100 mm

- 176.G0 blank
- 176.G1 farblos eloxiert
- 176.G2 bronzefarbig eloxiert

Lagerlänge 2500 mm

- 176.G01 blank
- 176.G11 farblos eloxiert
- 176.G21 bronzefarbig eloxiert

HEBGO-Schwellenprofil aus Aluminium
Steckprofil

Lagerlänge 5250 mm (☼ = 5)

- 177.W0 blank
- 177.W1 farblos eloxiert
- 177.W2 bronzefarbig eloxiert

- 179.W0 blank
- 179.W1 farblos eloxiert
- 179.W2 bronzefarbig eloxiert

HEBGO-Lippendichtung, TPE-Qualität

Rollen à 50 m

- 620.1 schwarz
- 620.2 braun

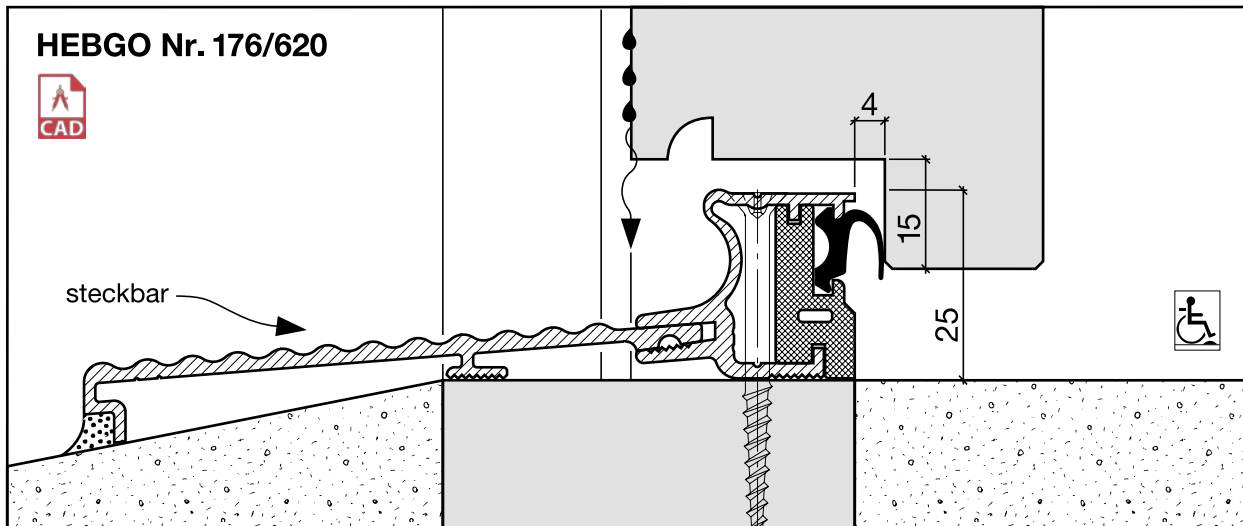

Variante "Plus" (mit Schleifdichtung für extreme Schlagregensicherheit)

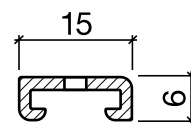
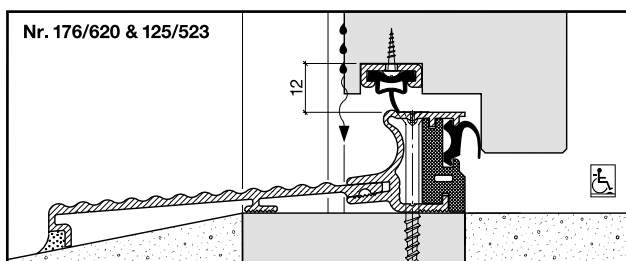

Nr. 125



Nr. 523

Profildetails siehe Seite B, 08